

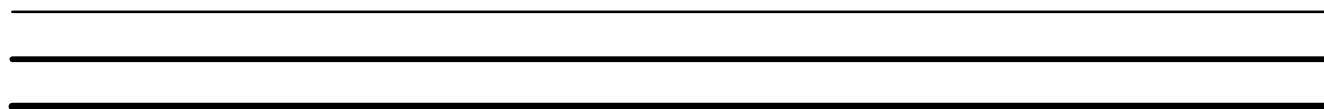

5 phase stepping motor driver

IMS50 series



【User's manual】

**MYCOM**

MYCOM, INC.

## Safety precautions

Please read this operation manual thoroughly before starting any operation. This manual will guide the customers for proper use and avoid any mis-operation. This manual if properly read, will protect the users as well as other people from possibilities physical injuries, property damage and other serious accidents.



**DANGER**

Indicates a possibility of causing serious injury or worst, death to the user, caused by fire or electric shock if this warning is ignored. Also indicates that the equipment has the highest degree of causing damage.



**WARNING**

This shows the possibility that the user may get serious injury by fire or electrical shock if this warning is neglected.



**CAUTION**

This shows the possibility that may cause slight injury or damage to this product or other equipment.

### **DANGER**

- Do not operate this product if it is damaged or disassembled. Otherwise, it may cause fire or electrical shock.
- In any case, do not attempt to repair or modify this product as it may cause fire, electrical shock or serious injuries.
- Do not use this product, in a place where the air includes a corrosive gas, inflammable gas, or any type of explosive gas, or the water or oil splashes, or it is near a flammable material. Otherwise, it may cause fire or electrical shock.
- Leave works such as installation, wiring, operation, checking and maintenance to experts who have enough knowledge on this product. Operation without knowledge may cause electrical shock and other serious physical or property damages.
- Keep the power supply within the rated voltage range. Otherwise, it may cause fire or other damages.
- Make sure all the connections correctly done referring to the wiring diagram shown in this user's manual. Otherwise, it may cause fire or other damages.
- Do not, in any circumstances, touch the terminal block while the power is on as there are some terminals which high voltage appeared. Otherwise, it may cause electrical shock.
- Do not touch or place objects such as metals or foreign substance on the board. Otherwise, it may cause fire or electrical shock.
- Do not bend, pull or place the power or motor cables by the extreme force. Otherwise, it may cause fire or electrical shock.
- Do not make a mistake connecting the motor output terminals to protective earth or power supply. Otherwise, it may cause fire.
- Do not do the driver's installation preventing ventilation. Otherwise, it may cause fire.

- When the “HEAT” is activate, stop the pulse signal. Otherwise, it may cause fire. (Only the product have a Overheat function.)

 **WARNING**

- Do not attempt any type of works such as moving the machine, wiring, maintenance, checking while the power is on. It is recommended that such works should be done only when more than ten seconds have elapsed after the power is off. Otherwise, it may cause electrical shock.
- Do not touch this product with wet hands while the power is on. Otherwise, it may cause electrical shock.
- Connect the protective earth terminal (PE) properly to it on your equipment, as illustrated in this user’s manual. Otherwise, it may cause electrical shock.
- Use this product which installed properly in the enclosure. Otherwise, it may cause electrical shock or injury.
- Do not leave the cover off from the terminal block while the power is on. Otherwise, it may cause electrical shock or injury.
- Fix this product securely onto your equipment. Otherwise, it may cause injury.
- Do not touch this product while it is running or right after it is stopped. Otherwise, it may cause injury, as its surface remains hot.
- Depending on the setting of this product, it may show an unexpected operation when recovering from overheating. Please read this user’s manual carefully and pay a special attention.
- Use a DC power supply with reinforced insulation for dangerous voltage. Otherwise, it may cause electrical shock. (Only DC input type)

 **CAUTION**

- Do not use or store this product under a dusty environment. Otherwise, it may cause malfunction.
- Do not give a big shock to this product. Otherwise, it may cause malfunction.
- Do not use or store this product in a place of high or low temperature, or under an environment of extremely high or low humidity. Otherwise, it may cause short circuit to your device or further damage.
- Do not install this product in a place where a dew is generated. Otherwise, it may cause short circuit to your device or further damage.
- MYCOM is, in no way, responsible for any damages or malfunctions that are caused by user’s repair or modifications on this driver. If the user performed these initiations and the driver does not work satisfactorily, a warranty will not be provided.
- When giving up the use of the driver, dispose it according to an appropriate regulation on the industrial waste.
- Please do not remove the name plate.

If necessary, we would ask the trading company or distributor to translate this manual into the importer’s mother language.

# Index

1. Specification of driver	1
1-1. IMS50-110/IMS50-120	1
1-2. IMS50-210/IMS50-220	2
2. Model number & Factory default	3
2-1. Model number of set	3
2-2. Driver model number	4
2-3. Factory default	4
3. Pulse waveform	5
3-1. Input pulse type	5
3-2. Pulse waveform	6
4. Each part name and functions	7
4-1. Each part name	7
4-2. Description of function	7
4-2-1. Power display LED (POWER)	7
4-2-2. Excitation home display LED (MONI)	8
4-2-3. Overheat display LED (HEAT)	8
4-2-4. Current off function (CO)	8
4-2-5. Auto current down function (A.CD)	8
4-2-6. Auto current off function (A.CO)	8
4-2-7. Setp Angle select switch (HALF/FULL)	8
4-2-8. Pulse input type select switch (2P/1P)	9
4-2-9. Signal I/O connector (CN-1)	9
4-2-10. Motor connector (MOTOR)	9
4-2-11. Power supply connector terminal (AC)	9
4-2-12. Protective earth terminal (PE)	9
5. Example of connection	10
6. Wiring and Install condition	10
6-1. Wiring for motor lines and power lines	10
6-2. Wiring of motor line	10
6-3. Wiring of signal line	10
6-4. Applicable solder-less terminal	13
6-5. Tightening torque for terminal block	13
6-6. Install condition	13
7. Dimension	14
7-1. Dimension of IMS50-110	14
7-2. Dimension of IMS50-120	15
7-3. Dimension of IMS50-210/IMS50-220	16
8. List of equivalent motor	17

9. OPTION.....18

# 1. Specification of driver

## 1-1. IMS50-110/IMS50-120

Model number	IMS50-110	IMS50-120
Power source	Single phase 100-120V $\pm$ 10% 50/60Hz	Single phase 200-220V $\pm$ 10% 50/60Hz
Power consumption	400VA or less	500VA or less
Driving type	Star bi-polar type	
Output current	1.4A/phase	
Step Angle	Basic step (FULL) , Half step (HALF)	
Function	Auto-current down (Only IMS50-110), Auto-current off, Input of output current off, Exciting timing output, Overheat output	
Signal input	Photocoupler input; Input resistance 390 Input signal voltage: L : 0 - 0.5V, H : 4 - 5V 1 pulse type (PLUSE, CW/CCW), 2 pulse type ( CW, CCW), CO	
Signal output	Photocoupler open-collector output, Limited capacity 25V 10mA or less, MONI, HEAT	
Dielectric Strength	No abnormality detected after the application of the below voltage among each terminal for one second in normal temperature and humidity.	
	2.0kV(60Hz)	3.0kV(60Hz)
Insulation Resistance	100M or higher with DC500V Meger applied in normal temperature and humidity.	
	<ul style="list-style-type: none"> <li>• Power input: Motor leads collection terminal - PE terminal</li> <li>• Power input: Motor leads collection terminal - Signal I/O terminal</li> </ul>	
Operating temperature environment	0 to +40 No freezing	
Operating humidity environment	Less than 80%, No condensation	
Storing temperature environment	-10 to +60 No freezing	
Storing humidity	Less than 80%, No condensation	
Operating height	Less than 1,000m from sea level	
Atmosphere	In the room without corrosive gas, inflammable gas and dust. Without splashing water and oil.	
Applicable Standard	EN60950	
Weight	1000 g	
Accessories	User's manual (This book)	
Applicable Motor	CE marking approved	PCE5641-AC(BC), PCE 5661-AC(BC), PCE 5691-AC(BC) PCE 5961-AC(BC), PCE 5991-AC(BC) , PCE 59131-AC(BC)

## 1-2. IMS50-210/IMS50-220

Driver model	IMS50-210	IMS50-220
Power source	Single phase 100-120V $\pm$ 10% 50/60Hz	Single phase 200-220V $\pm$ 10% 50/60Hz
Power consumption	620VA or less	850VA or less
Driving type	Star bi-polar type	
Output current	2.8A/phase	
Step Angle	Basic step (FULL) , Half step (HALF)	
Function	Auto-current down, Auto-current off, Input of output current off, Exciting timing output, Overheat output	
Signal input	Photocoupler input: Input resistance 390 Input signal voltage: L : 0 - 0.5V, H : 4 - 5V 1 pulse type (PLUSE, CW/CCW), 2 pulse type (CW, CCW), CO	
Signal output	Photocoupler open-collector output, Limited capacity 25V 10mA or less, MONI, HEAT	
Dielectric Strength	No abnormality detected after the application of the below voltage among each terminal for one second in normal temperature and humidity. <ul style="list-style-type: none"> <li>• Power input: Motor leads collection terminal - PE terminal</li> <li>• Power input: Motor leads collection terminal - Signal I/O terminal</li> </ul>	
	2.0kV(60Hz)	3.0kV(60Hz)
Insulation Resistance	100M or higher with DC500V Meger applied in normal temperature and humidity. <ul style="list-style-type: none"> <li>• Power input: Motor leads collection terminal - PE terminal</li> <li>• Power input: Motor leads collection terminal - Signal I/O terminal</li> </ul>	
Operating temperature environment	0 to +40 No freezing	
Operating humidity environment	Less than 80%, No condensation	
Storing temperature environment	-10 to +60 No freezing	
Storing humidity	Less than 80%, No condensation	
Operating height	Less than 1,000m from sea level	
Atmosphere	In the room without corrosive gas, inflammable gas and dust. Without splashing water and oil.	
Applicable Standard	EN60950	
Weight	1000 g	
Accessories	User's manual (This book)	
Applicable Motor	CE marking approved	PCE 5692-AC(BC), PCE 5962-AC(BC), PCE 5992-AC(BC) , PCE 59132-AC(BC)

## 2. Model number & Factory default

### 2-1. Model number of set

**IMS 5 0 - 1 1 0 - 5 6 6 1 B C**

Series name

Extension of set



List of motor and driver combination

Series name, IMS50			
Extension of set	Motor model	CE marking	Driver model
5641AC(BC)	PCE 5641-AC(BC)	approved	IMS50-110 IMS50-120
5661AC(BC)	PCE 5661-AC(BC)		
5691AC(BC)	PCE 5691-AC(BC)		
5961AC(BC)	PCE 5961-AC(BC)		
5991AC(BC)	PCE 5991-AC(BC)		
59131AC(BC)	PCE 59131-AC(BC)		
5692AC(BC)	PCE 5692-AC(BC)	approved	IMS50-210 IMS50-220
5962AC(BC)	PCE 5962-AC(BC)		
5992AC(BC)	PCE 5992-AC(BC)		
59132AC(BC)	PCE 59132-AC(BC)		



Attention

- Please use our CE marked PCE series motor.
- Please use the motor in safety condition after careful confirmation of using condition, heating and ground setting if another motor than CE marked motor is used.



### 3. Pulse waveform

#### 3-1. Input pulse type

F

- 2 pulses type  
Timing chart

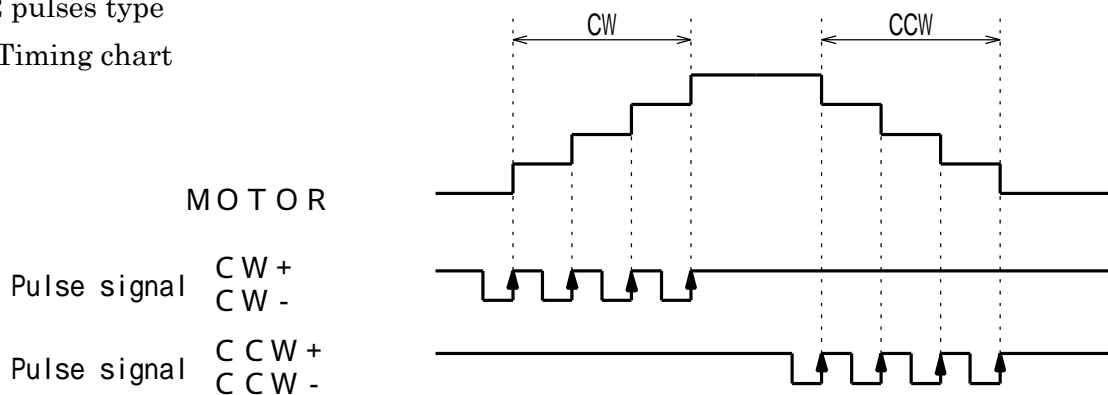

Motor starts to rotate by rising edge( ) of CCW or CW signal.

- 1 pulse type  
Timing chart

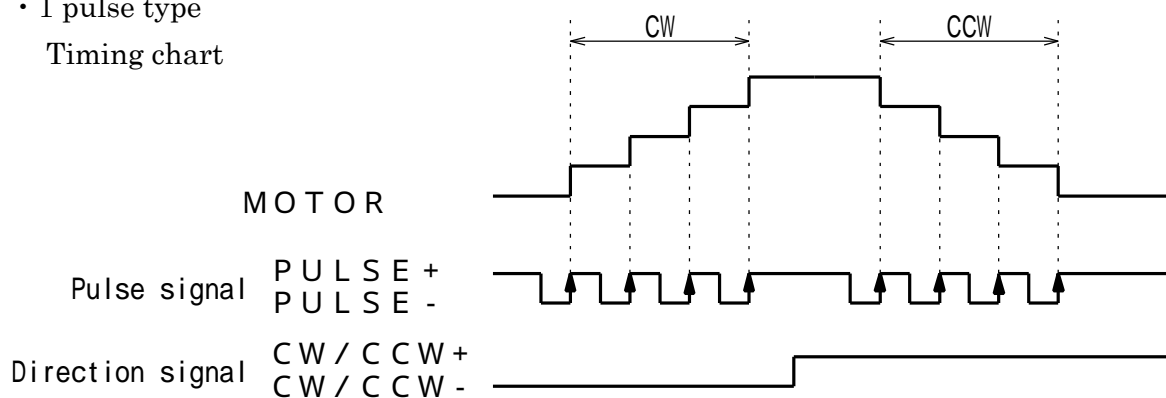

Motor starts to rotate by rising edge( ) of Pulse signal.

### 3-2. Pulse waveform



#### • 2 pulses type

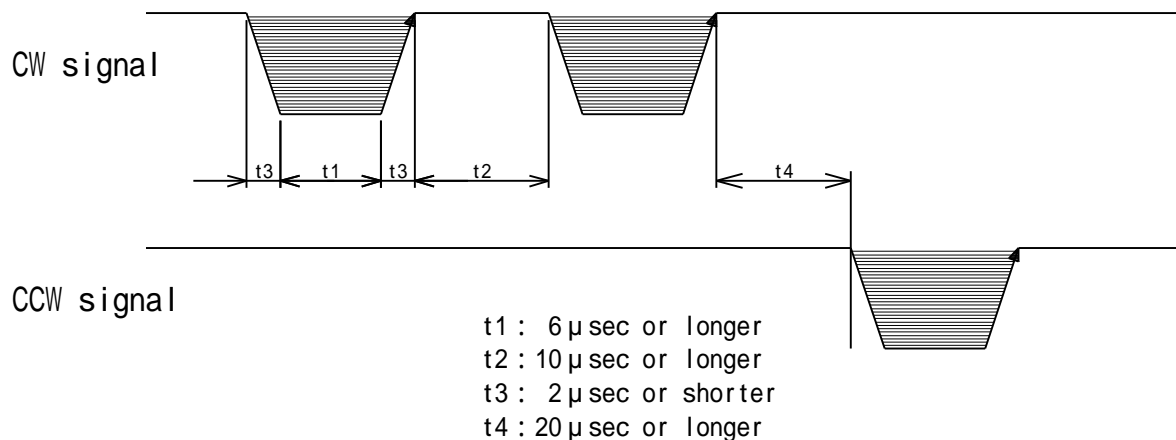

- section shows ON status(turn on of photo coupler) of input circuit photo coupler.
- Motor starts to rotate by rising edge( ) of CCW or CW signal.

#### • 1 pulse type

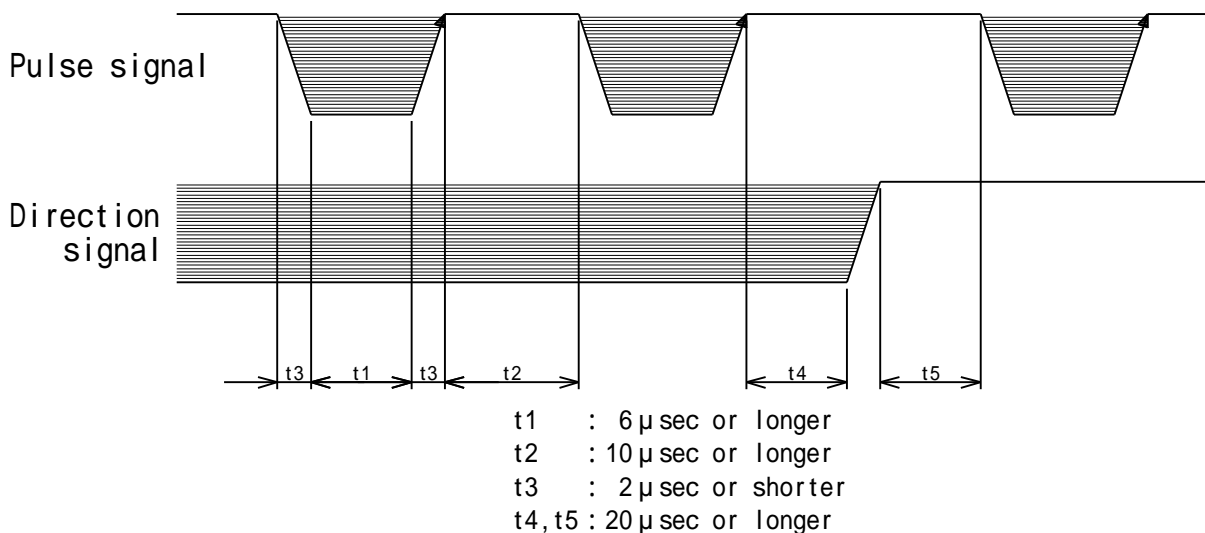

- section shows ON status(turn on of photo coupler) of input circuit photo coupler.
- Motor starts to rotate by rising edge( ) of pulse signal.
- Direction signal input is to rotate CW direction by inputting pulse signal at ON status. Also if pulse is inputted at OFF status, motor rotates to CCW direction.
- Signal name of product uses pulse signal as CW input and direction signal as CCW input.

#### Attention

- 1 . If the signal exceeds the voltage of DC5V in use, please insert the series resistor near to output terminal(connector) of using controller so that 10mA current pass.

Value of resistor to be inserted( ) =  $\frac{\text{Input voltage} - 5V}{10\text{mA}}$  - Register value of wiring( )

- 2 . Current down function is invalid if the photo coupler of pulse input keeps ON status at stopping.

## 4. Each part name and functions

### 4-1. Each part name

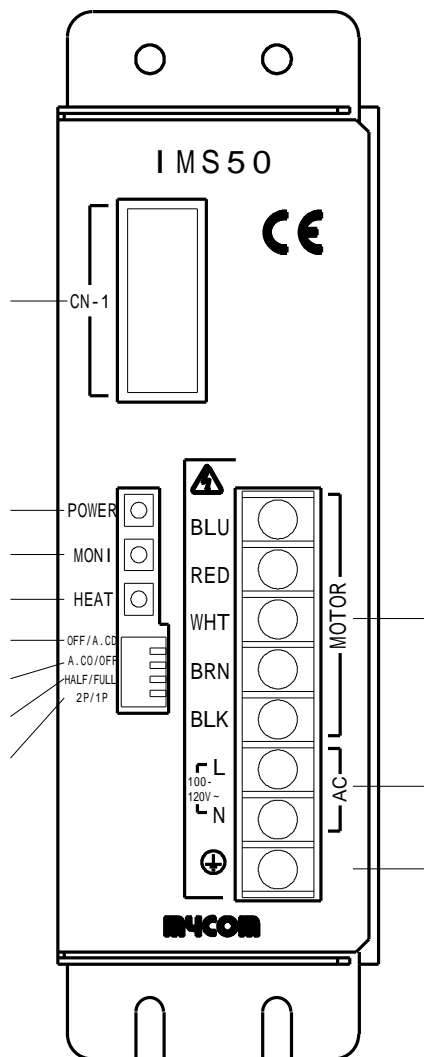

LED Power display LED

This lights on during power on.

Excitation home display LED

This lights on when excitation home.

Overheat display LED

This lights on when overheat.

OFF/A.CO (Switching of Auto current down function)

This turns valid/invalid the auto current down function.

( except IMS50-120 )

A.CO/OFF (Switching of Auto current off function)

This turns valid/invalid the auto current off function.

Step Angle Config

FULL/HALF changes excitation mode

2P/1P, (Switching of input pulse type)

This switches the input pulse type

Signal I/O connector

Various I/O signals are connected.

Motor connector terminal

Connect in accordance with the color of Motor leads.

Power connector terminal

Connect power.

Protective earth terminal(PE)

Connect with the protective earth terminal of

The machine.

External diagram of front panel

( IMS50-110 )

\*Note A figure is IMS50-110/IMS 50-210, and LN portion of AC becomes "200-220V - "  
in IMS50-120/IMS 50-220.

### 4-2. Description of function

#### 4-2-1. Power display LED (POWER)

This lights on during power on.

Though POWER LED and MONI LED blink for a few seconds after power off, it is not abnormal.

Only IMS50-110/IMS50-210

### 4-2-2. Excitation home display LED (MONI)

This lights on when the output excitation pattern is excitation home.

Then the signal is outputted to MONI terminal of CN-1.

### 4-2-3. Overheat display LED (HEAT)

This lights on when the temperature of internal heat-sink exceeds about 70 .

Then a signal is outputted to the HEAT output of CN-1.

### 4-2-4. Current off function (CO)

The signal between CO ± of CN-1 can control the excitation or non-excitation of motor.

H level : excitation off (A photo-coupler is at the 'ON' time.)

L level (or no connection) : excitation on

### 4-2-5. Auto current down function (A.CD)

This reduces the motor driving current to 50% of normal current and temperature rising of motor after the motor stops and 200ms. later.

OFF/A.CD switch (4-1 External diagram ) can release the function.

(The auto-current-down function of IMS50-120 is impossible to cancel. )

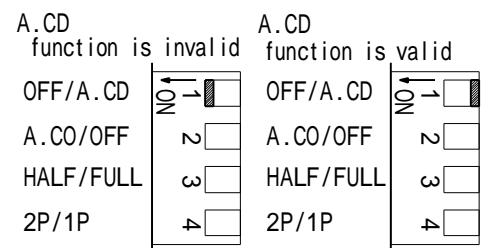

### 4-2-6. Auto current off function (A.CO)

When the temperature of driver inside rises and becomes overheat condition, this function automatically excites off.

A.CO/OFF switch (4-1 External diagram ) can release the function.

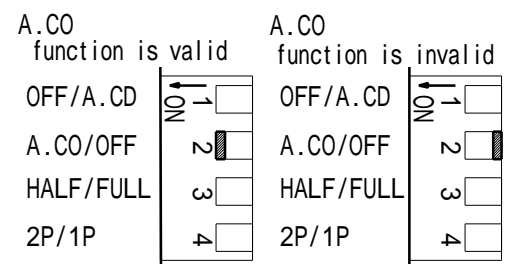

### 4-2-7. Setp Angle select switch (HALF/FULL)

FULL/HALF changes excitation mode, and sets up the step angle.

FULL (Basic Step):4 phase excitation

HALF (Half Step):4-5 phase excitation

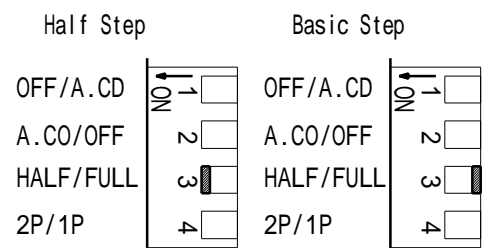

### 4-2-8. Pulse input type select switch (2P/1P)

2P/1P switch sets the driving pulse to 2 pulse type or 1 pulse type by 2P/1P switch (4-1 External diagram ). Please refer 3. Pulse waveform about input type.

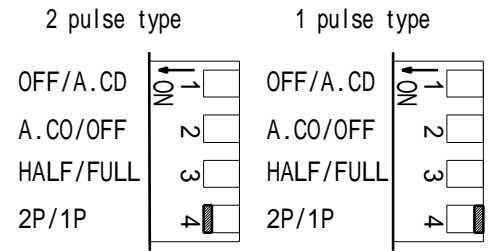

### 4-2-9. Signal I/O connector (CN-1)

This is to be connected with driving pulse, current off signal and various monitor signals.

Connector pin assignment			
1	CW+	6	CO-
2	CW -	7	MONI+
3	CCW+	8	HEAT+
4	CCW -	9	COM -
5	CO+		

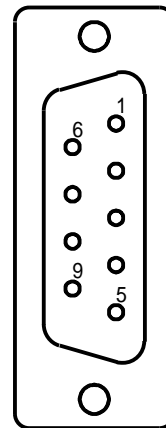

(Front panel side)

Connector combination 9 pin D-sub connector Socket type

Connector : OMRON, XM2D-0901 equivalent

Hood : OMRON, XM2S-0911 equivalent ( M2.6 × 0.45 )

### 4-2-10. Motor connector (MOTOR)

This is connected according to the motor lead color.

### 4-2-11. Power supply connector terminal (AC)

In case of 100V type driver, connect single-phase 100V-120V 50/60Hz power supply.

In case of 200V type driver, connect single-phase 200V-220V 50/60Hz power supply.

Use AWG18(0.75mm<sup>2</sup>) or bigger wire.

### 4-2-12. Protective earth terminal (PE)

Connect with the protective earth terminal of the machine by thickness more than a power supply line for safety.

## 5. Example of connection

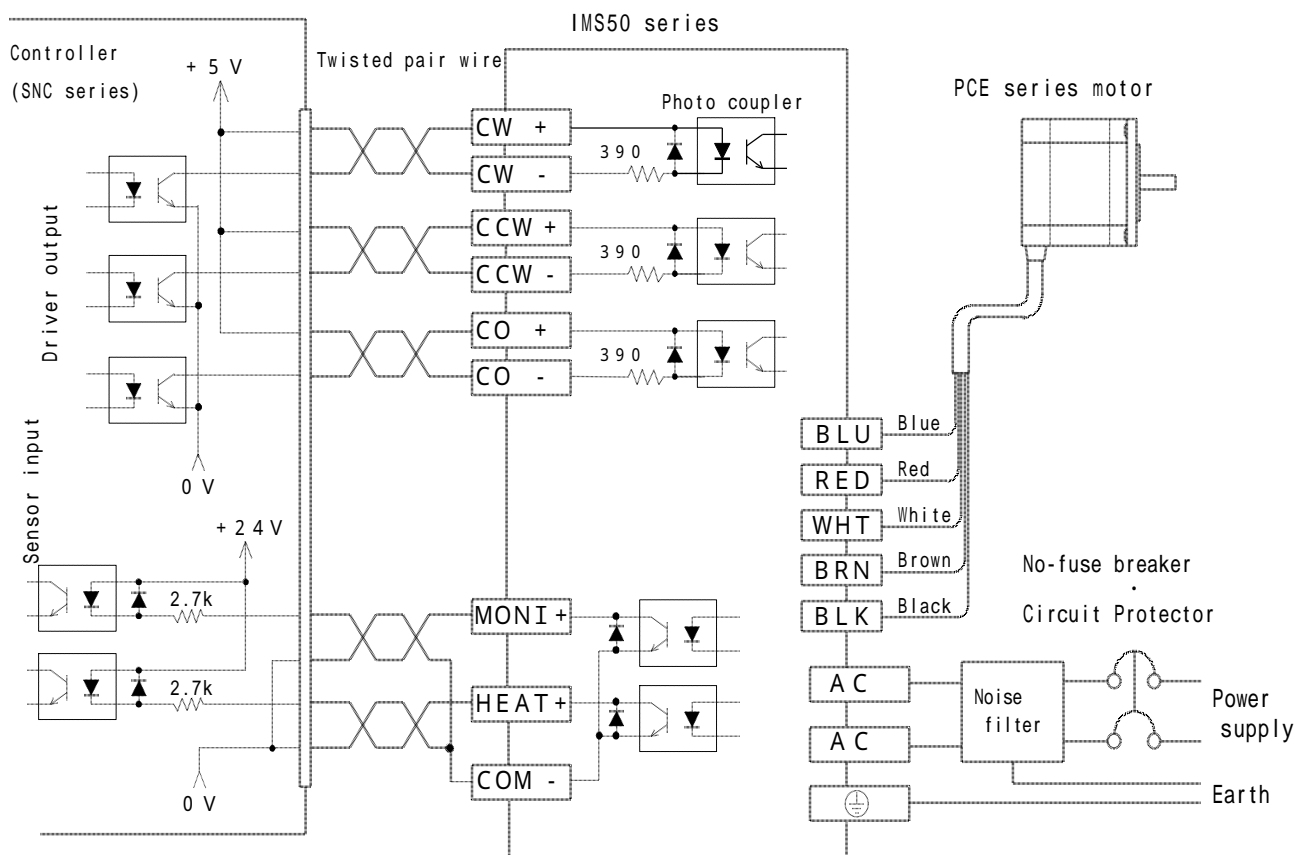

## 6. Wiring and Install condition

### 6-1. Wiring for motor lines and power lines

- When wiring, surely wire the protect earth line at first.
- If the motor line becomes longer, radiation noise can be depressed with shield wire using.
- Install noise filter at power input where noise sources exist near the driver.
- This driver has fuse inside, but use no-fuse-breaker or circuit protector of the capacity of below table for safety.
- It is very dangerous to connect AC power with motor output.

Driver model	Current capacity
IMS50-110	5 A
IMS50-120	3 A
IMS50-210	8 A
IMS50-220	5 A

### 6-2. Wiring of motor line

- The radiant noise can be depressed by shield cable equal to or bigger than AWG22(0.5mm<sup>2</sup>) in case that redundant radiant noise is trouble. D
- In case that the motor wiring is longer, please use the shield cable equal to or bigger than AWG22(0.5mm<sup>2</sup>) D

### 6-3. Wiring of signal line

If the following procedure is not made, there may be a cause of incorrect operation.

- Use bigger cable than AWG28 which suits with the connector.

- Use twisted pair line or shield line.
- of twisted pair wiring diagram is recommended in case of twisted pair line but select and use a suitable diagram of to depending on cable and environment. However do not wire as A to C.

Twisted pair wiring diagram

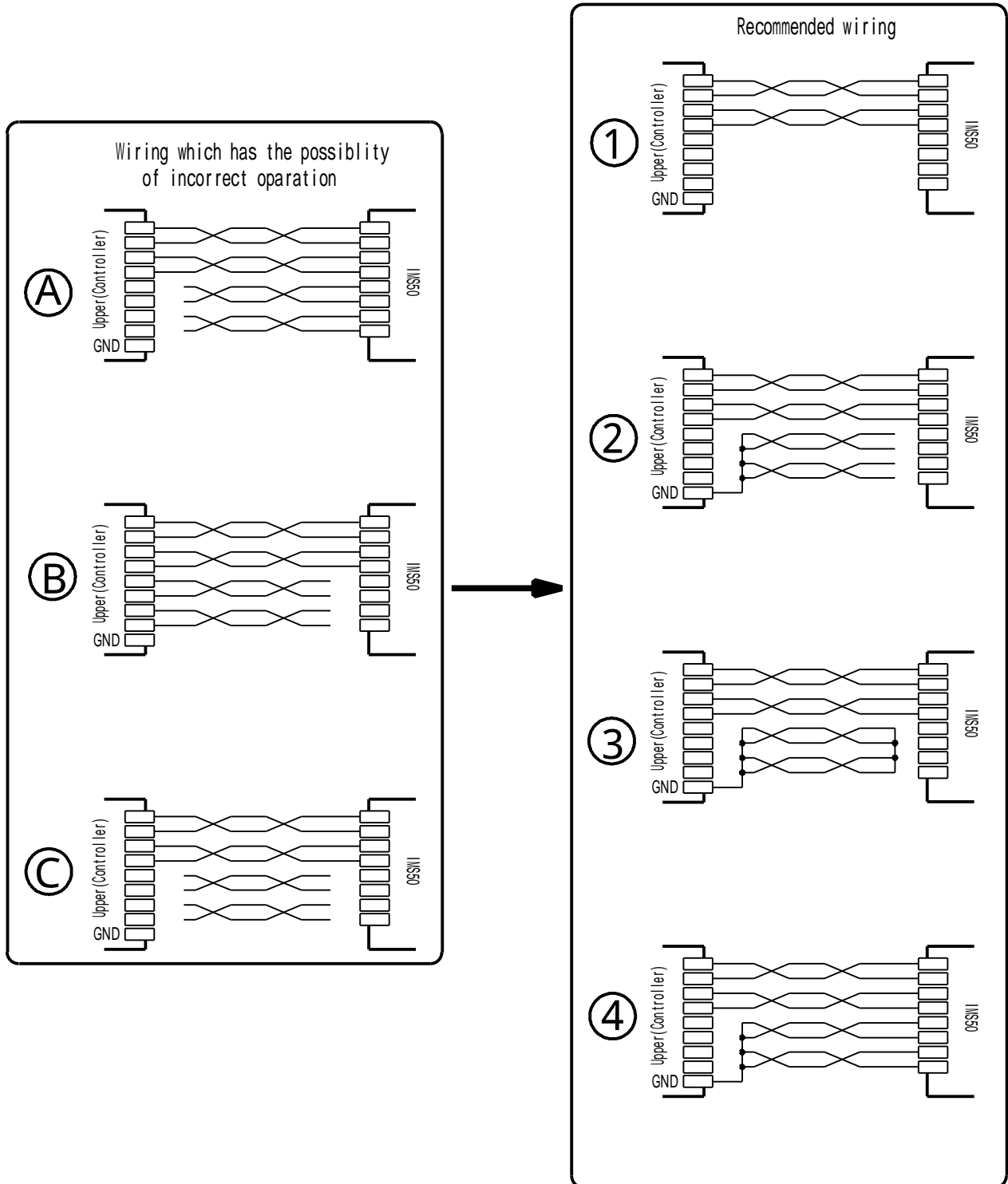

- of shield line wiring diagram is recommended in case of shield line but select and use a suitable diagram of to depending on cable and environment. However do not wire as A to C.

Shield line wiring diagram

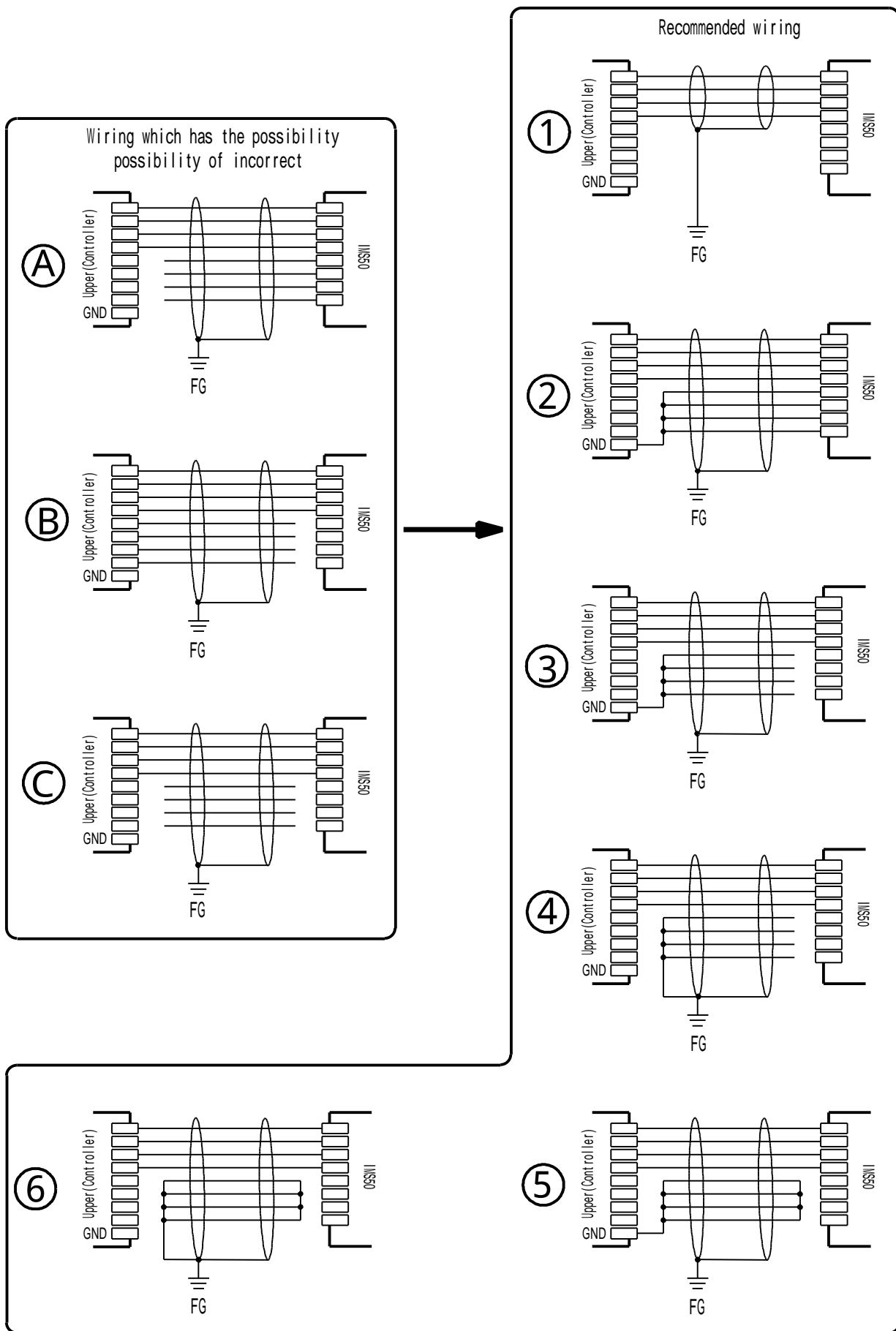

### 6-4. Applicable solder-less terminal

Use insulated ring tongue terminal to connect with terminals.

V1.25-MS3(J.S.T), TGV1.25-3(NICHIFU) or equivalent

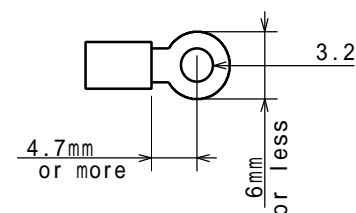

### 6-5. Tightening torque for terminal block.



Do not add vertical force against screw when connecting with terminal.

Please tighten the screw within torque of  $0.392 \sim 0.686\text{N} \cdot \text{m}$  ( $4 \sim 7\text{Kgf} \cdot \text{cm}$ ) at stopping.

### 6-6. Install condition

- Do not use driver outside of control box. This unit is designed for the following condition. 

Over voltage category: Category II, Material group III

Pollution degree: Class 2

Protection structure: IP20

Protection against electric shock: Class I component

- Fix driver on heat conductive metal plate tightly.
- Put 3cm or more space between each driver and fix the drivers when multiple drivers are arranged.
- Pay attention not to close the side slits of driver.
- Put this unit vertically because this unit radiates by natural convection. (INS50-110 and INS50-120) see right fig.
- Confirm that the driver environmental temperature is less than 40 when overheat LED lights.
- Use M4 screws of “thickness of installing place plus 3”
- Because this unit uses high speed photocoupler for the part of input pulse, use the shield line for signal cable.
- Please do not connect the signal line which is not used. It becomes the cause of incorrect operation.

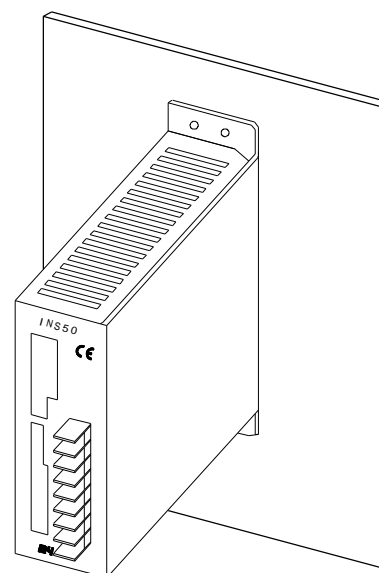

### Caution

There is a possibility that driver chassis temperature exceeds 60 depending on environmental condition.

# 7. Dimension

## 7-1. Dimension of IMS50-110

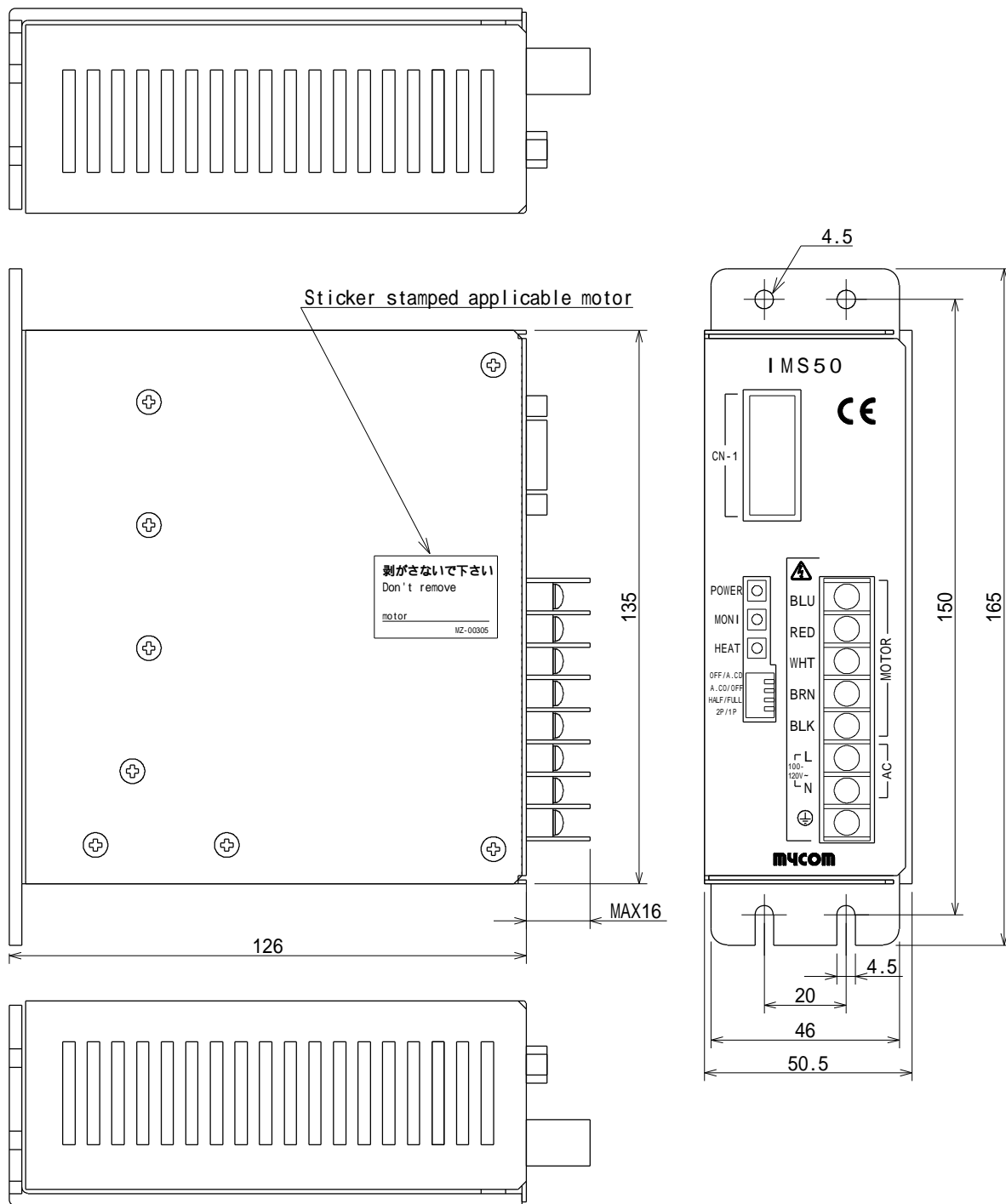

Unit : mm, The screw head is not included.



7-3. Dimension of IMS50-210/IMS50-220

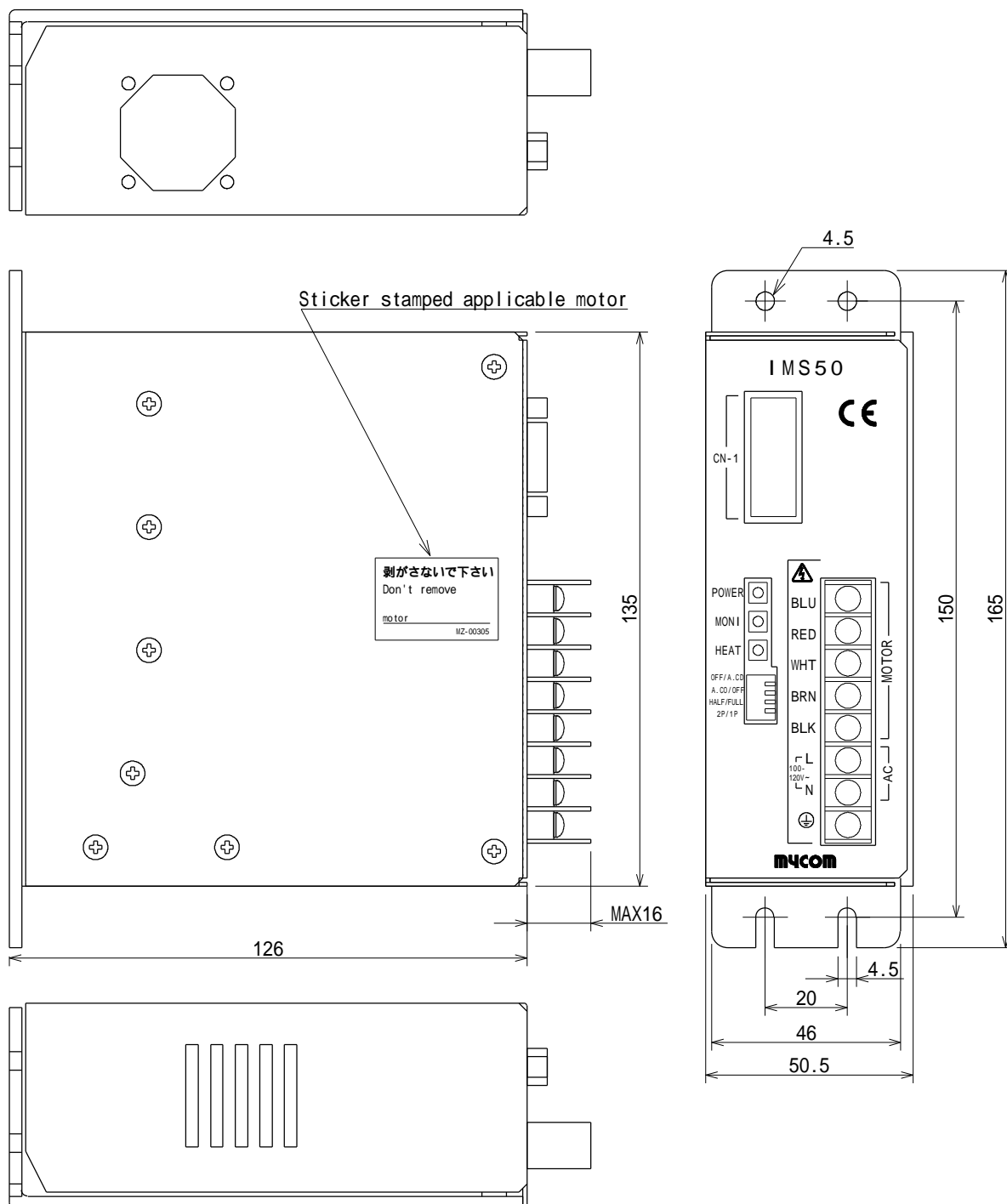

Unit : mm, The screw head is not included.

The dimension is IMS50-210. In case of IMS50-220, LN portion of AC is "200-220V ~".

## 8. List of equivalent motor

	Standard motor	Equivalent motor
Output current 1.4A/phase	PCE5641-AC(BC)	PF564-A(B)
	PCE5661-AC(BC)	PF566-A(B)
	PCE5691-AC(BC)	PF569-A(B)
	PCE5961-AC(BC)	PF596-A(B)
	PCE5991-AC(BC)	PF599-A(B)
	PCE59131-AC(BC)	PF5913-A(B)
Output current 2.8A/phase	PCE5692-AC(BC)	PF569H-A(B)
	PCE5962-AC(BC)	PF596H-A(B)
	PCE5992-AC(BC)	PF599H-A(B)
	PCE59132-AC(BC)	PF5913H-A(B)

Only numeral part of standard motor is printed at the applicable motor sticker.

Therefore, for example, in case of PCE5641-AC(BC) and PF564-A(B), “5641” is printed at the applicable motor sticker.

## 9. OPTION

It is available to supply the following optional cables which have covering connector at the one side.

one side.

- C N 1 : Pulse cable

Model number : O P C - D S 9 P 1 5

Connector : 9 pin D-sub

Cable : AWG 2 8 Multi-heart cable with a shield 1.5m

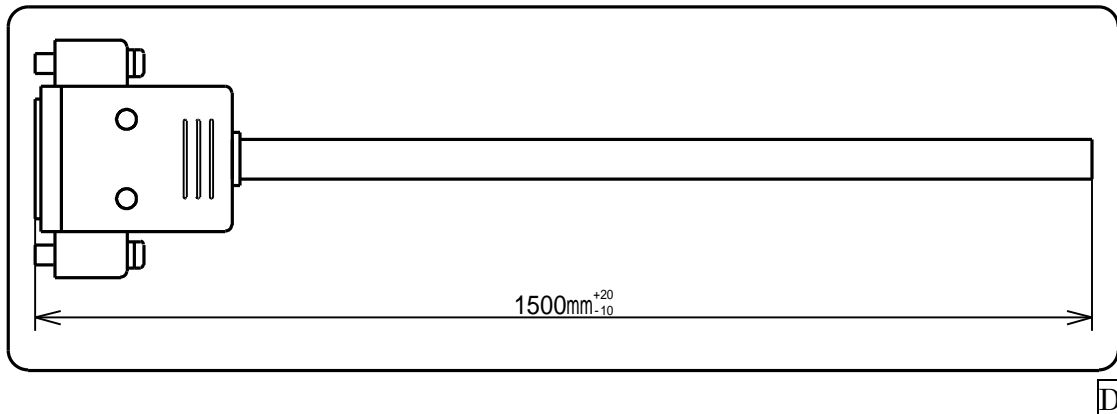

Connect the unused cables with the ground of the upper. Otherwise it may become the cause of incorrect operation. Please refer 6-3 “Wiring of signal line” for the detail.

- Motor Cable

Model number : O M C - N C 5 P 1 5

Cable : AWG 2 0 Both-ends end Shield-less multi-heart cable 1.5m

D

Please understand that we may make modifications to our products without notification in order to improve the capabilities and external appearance of our products.

---

## **MYCOM**

MYCOM, INC. (Head office)

12, S. Shimobano, Saga hirosawa, Ukyo, Kyoto, Japan 616-8303

TEL: 81-75-882-3601 FAX : 81-75-882-6531

Home Page : <http://www.mycom-japan.co.jp/>

NYDEN CORP.

2610, North First St. #B San Jose, Ca, 95134, USA

TEL: 1-408-232-7700

Home Page: <http://www.nyden.com>

MYCOM TECHNOLOGY, INC.

2Fl., No.333, Fuhsing N, Road Taipei, Taiwan, R.O.C.

TEL : 886-2-2719-0525

MYCOM KOREA, INC.

RM. C-605, Woolim Lions Valley, Geum Cheon-Gu, Gasan-dong, Seoul, Korea

TEL : 02-2635-6703 ~ 4

MYCOM THCHNOLOGY (SINGAPORE) PTE. LTD.

No.1, Sims Lane #05-05, One Sims Lane, Singapore 387355

TEL : 65-6743-4476

Home Page : <http://www.mycommts.com.sg>

Malaysian Contact;

No.1E-12-07, Jalan Batu Uban, Sunny Ville, Penang, Malaysia

TEL : 60-04-656-0328